

BRIDGE TRIPOD TURNSTILE NEPTUN CP-124

NEPTUN CP-124 waist high turnstiles have three rotating arms that block or allow passage when activated. These arms rotate in one direction and typically return to their default position after each use. The blocking and releasing are achieved by rotation. Tripod turnstiles are commonly used in a variety of settings to enhance security, manage access, and prevent unauthorized entry.

Tripod turnstiles can be configured for uni-directional or bi-directional use. In uni-directional mode, they permit passage in only one direction, while in bi-directional mode, they allow entry and exit through the same turnstile.

Tripod turnstile features lights and audible signals to inform users whether access is granted or denied, promoting smooth and efficient passage.

Tripod turnstiles are made of sturdy materials such as 304 stainless steel and they are durable and resistant to wear and tear, even in high traffic areas.



30-40

PASSING SPEED



2

BI-DIRECTION



110V-220V

POWER SUPPLY



ANTI-TAILGATING



IP 41

PROTECTIVE LEVEL

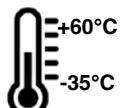

+60°C

-35°C

TEMPERATURE RANGE

Dimension	1200*280*980mm (3.94*0.92*3.22ft) (standard)
Passage Width	550mm (1.80ft) (standard)
Arm Length	510mm (1.67ft)
Frame Material	304 stainless steel and acrylic top cover (standard) , 316 stainless steel, Powder coated
Mechanism	Semi-automatic
Pass rate	30-40 person/min
Power Supply	100V-240V 50/60Hz
Drive Solenoid	DC 24V
Open Signal	Passive Relay (Dry Contact)
Communication	RS485
Working Direction	Bi-directional(standard), Unidirectional
Emergency	Automatic drop arm after power failure
Working Temperature	-35°C ~ 60°C
Working Environment	Indoor
Relative Humidity	95% Maximum

- **LED ALERTS** Indicate traffic direction with highly-visible green arrows and red X icons. The front LED will keep green arrows shows that the lane is available. If the lane is not available, it will turn red.
- **EMERGENCY EXIT** Functionality allows free passage in the event of an emergency.The arm will drop off when power outage. Manually reset when power is restored.
- **WORKING DIRECTION** Single directional or Bi-directional are optional.
- **AUTOMATIC RESET** Arms will lock automatically within 5s (adjustable) if a person delay to access.
- **ANTI-PASS BACK** The turnstile will stay in lock if someone wants to entry in the reverse direction.
- **ANTI-INTRUSION** the gate is locked automatically until a valid open signal is sent.
- **FAST UNLOCK** One there is a valid signal, the gate will unlock within 0.2s (adjustable).
- **HYDRAULIC DAMPER** Equipped with a hydraulic shock absorber for less noise during operation.
- **MOLD DESIGN** The mechanism is mold design. The components are more precise. It can save more labor cost and easier to assemble.

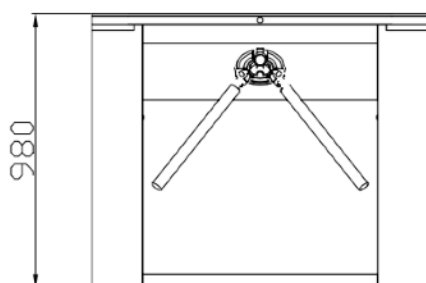
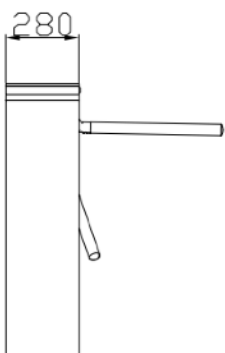
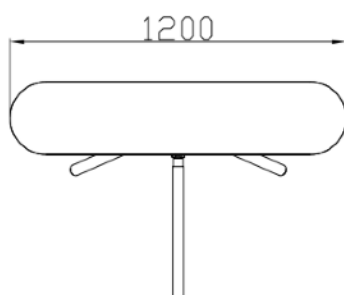
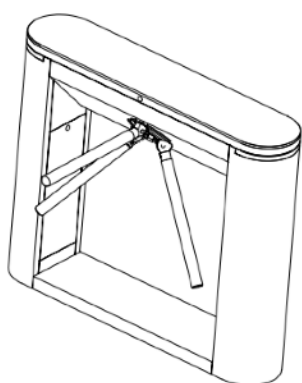

Our gates come with relay signals and RS485/RS232 interfaces. You can use your own access control system, or we can provide a complete access control system to you.



Remote control



RFID card



QR code/ barcode



Counter



Face recognition



Fingerprint recognition



Coin/ Card collection



Button

- Dimension: Can be made according to the client's site.
- The semi-automatic mechanism can be replaced with a fully automatic mechanism.
- Material: 304 stainless steel to 316 stainless steel (wet environment), or iron with powder coated. The outer paint finish can be colour coated to match the local environment.
- LED lights can be added.
- Mounting base can be added.
- Cutouts can be customized to fit any reader.
- LOGO can be customized.
- Customized 3D drawings are available based on the site photos.
- OEM& ODM service is available.

➤ Please check with sales for customization fees.



Cutouts can be customized to fit any reader.

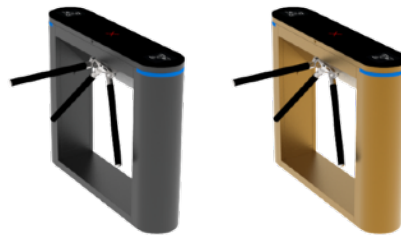

Other colors available, RAL or RGB required.

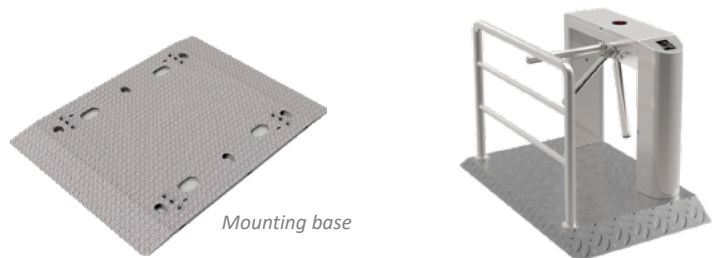

Mounting base

